

2A, 20V - 150V Schottky Barrier Surface Mount Rectifier

FEATURES

- AEC-Q101 qualified
- Low power loss, high efficiency
- Ideal for automated placement
- Guard ring for over-voltage protection
- High surge current capability
- Moisture sensitivity level: level 1, per J-STD-020
- RoHS Compliant
- Halogen-free

APPLICATIONS

- Low voltage, high frequency
- DC/DC converter
- Freewheeling diodes
- Reverse battery protection
- Car lighting

MECHANICAL DATA

- Case: DO-214AC (SMA)
- Molding compound meets UL 94V-0 flammability rating
- Terminal: Matte tin plated leads, solderable per J-STD-002
- Meet JESD 201 class 2 whisker test
- Polarity: Indicated by cathode band
- Weight: 0.070g (approximately)

KEY PARAMETERS		
PARAMETER	VALUE	UNIT
I_F	2	A
V_{RRM}	20 - 150	V
I_{FSM}	50	A
$T_{J\ MAX}$	125, 150	°C
Package	DO-214AC (SMA)	
Configuration	Single die	

DO-214AC (SMA)

ABSOLUTE MAXIMUM RATINGS ($T_A = 25^\circ\text{C}$ unless otherwise noted)										
PARAMETER	SYMBOL	SK	SK	SK	SK	SK	SK	SK	SK	UNIT
		22A	23A	24A	25A	26A	29A	210A	215A	
Marking code on the device		SK 22A	SK 23A	SK 24A	SK 25A	SK 26A	SK 29A	SK 210A	SK 215A	
Repetitive peak reverse voltage	V_{RRM}	20	30	40	50	60	90	100	150	V
Reverse voltage, total rms value	$V_{R(RMS)}$	14	21	28	35	42	63	70	105	V
Forward current	I_F	2								A
Surge peak forward current, 8.3ms single half sine-wave superimposed on rated load	I_{FSM}	50								A
Non-repetitive peak reverse avalanche energy, $L = 40\text{mH}$	E_{RSM}	20								mJ
Critical rate of rise of off-state voltage	dV/dt	10,000								V/ μs
Junction temperature	T_J	-55 to +125				-55 to +150				°C
Storage temperature	T_{STG}	-55 to +150								°C

THERMAL PERFORMANCE			
PARAMETER	SYMBOL	TYP	UNIT
Junction-to-ambient thermal resistance	$R_{\theta JA}$	88	°C/W

ELECTRICAL SPECIFICATIONS ($T_A = 25^\circ\text{C}$ unless otherwise noted)						
PARAMETER		CONDITIONS	SYMBOL	TYP	MAX	UNIT
Forward voltage ⁽¹⁾	SK22AH SK23AH SK24AH	$I_F = 2\text{A}, T_J = 25^\circ\text{C}$	V_F	-	0.50	V
	SK25AH SK26AH			-	0.70	V
	SK29AH SK210AH			-	0.85	V
	SK215AH			-	0.95	V
Reverse current @ rated V_R ⁽²⁾	SK22AH SK23AH SK24AH SK25AH SK26AH	$T_J = 25^\circ\text{C}$	I_R	-	0.5	mA
	SK29AH SK210AH SK215AH			-	0.1	mA
	SK22AH SK23AH SK24AH	$T_J = 100^\circ\text{C}$	I_R	-	10	mA
	SK25AH SK26AH			-	5	mA
	SK29AH SK210AH SK215AH			-	-	mA
	SK22AH SK23AH SK24AH SK25AH SK26AH			$T_J = 125^\circ\text{C}$	I_R	-
	SK29AH SK210AH SK215AH	-	2			mA

Notes:

1. Pulse test with $PW = 0.3\text{ms}$
2. Pulse test with $PW = 30\text{ms}$

ORDERING INFORMATION		
ORDERING CODE⁽¹⁾	PACKAGE	PACKING
SK2xAH	DO-214AC (SMA)	7,500 / Tape & Reel

Notes:

1. "x" defines voltage from 20V(SK22AH) to 150V(SK215AH)

CHARACTERISTICS CURVES

($T_A = 25^\circ\text{C}$ unless otherwise noted)

Fig.1 Forward Current Derating Curve

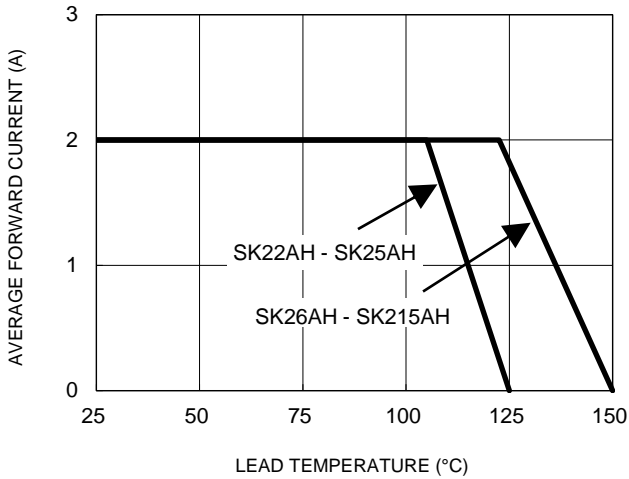

Fig.2 Typical Junction Capacitance

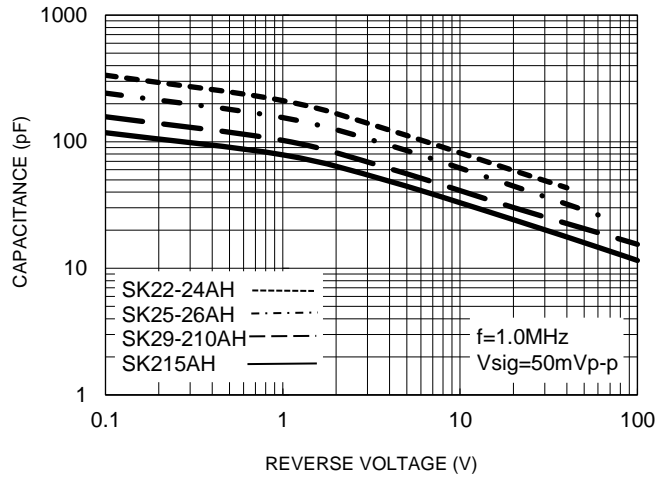

Fig.3 Typical Reverse Characteristics

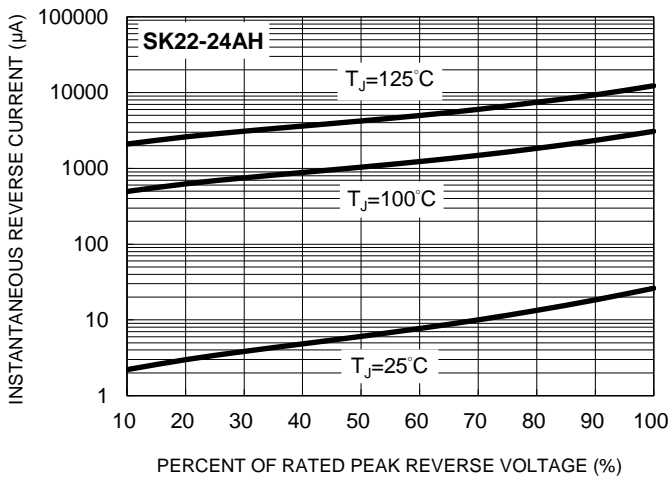

Fig.4 Typical Forward Characteristics

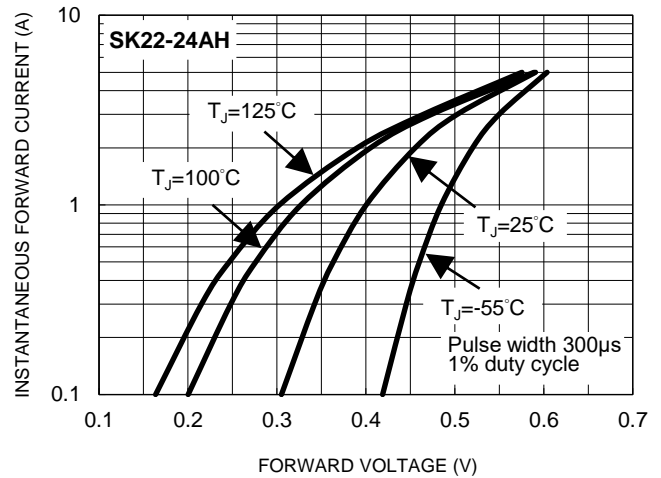

Fig.5 Typical Reverse Characteristics

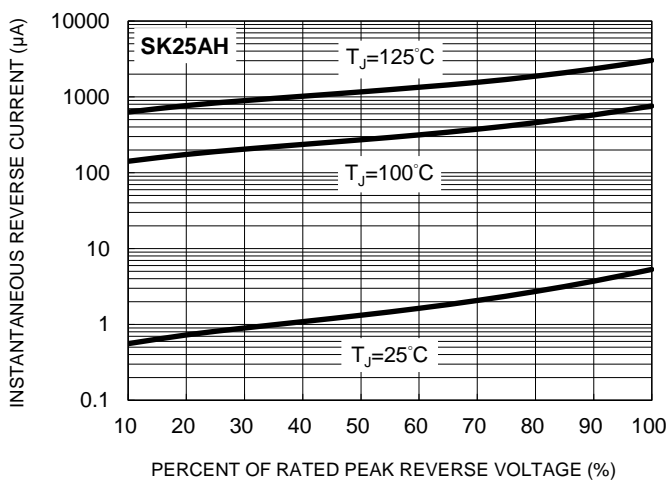
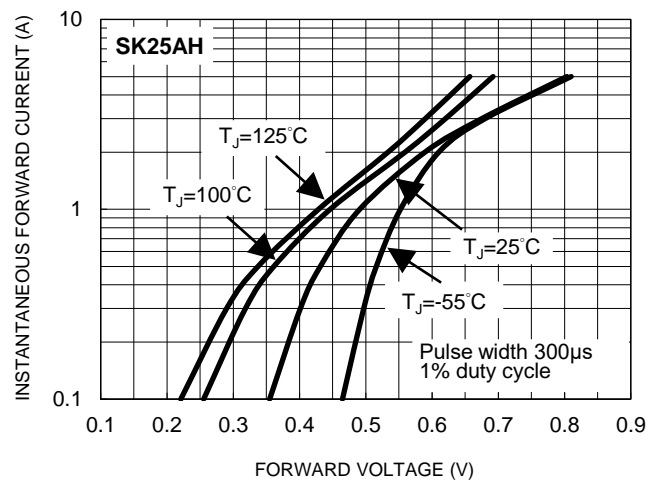

Fig.6 Typical Forward Characteristics



CHARACTERISTICS CURVES

($T_A = 25^\circ\text{C}$ unless otherwise noted)

Fig.7 Typical Reverse Characteristics

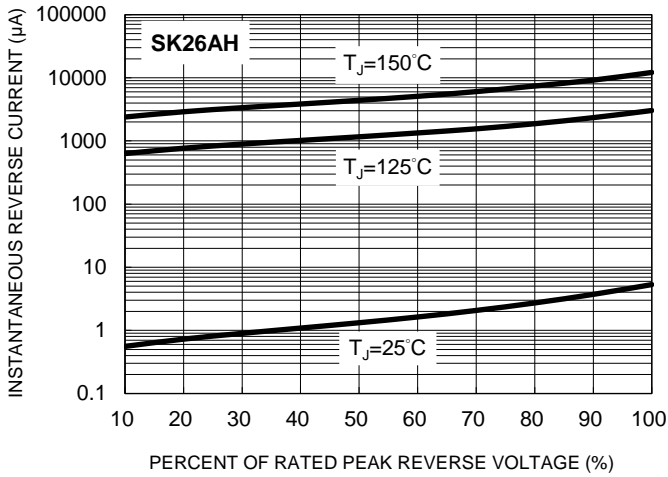

Fig.8 Typical Forward Characteristics

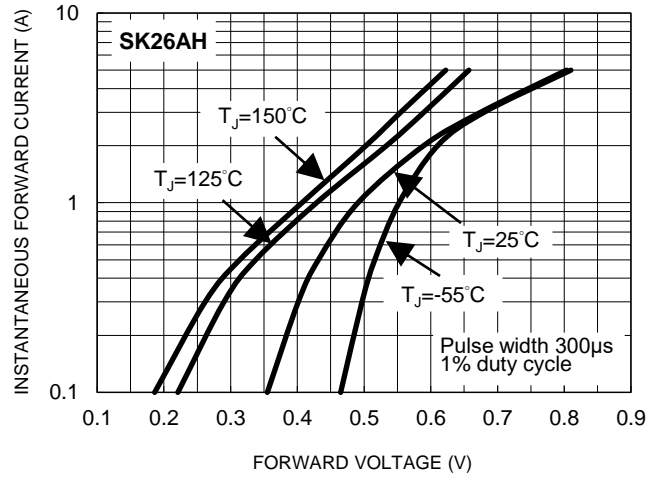

Fig.9 Typical Reverse Characteristics

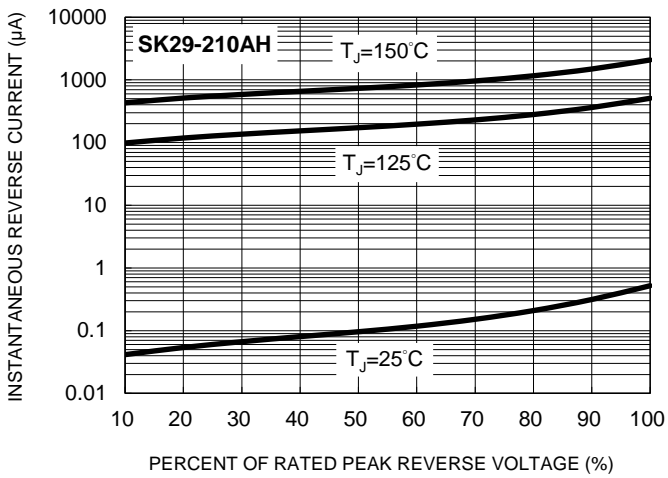

Fig.10 Typical Forward Characteristics

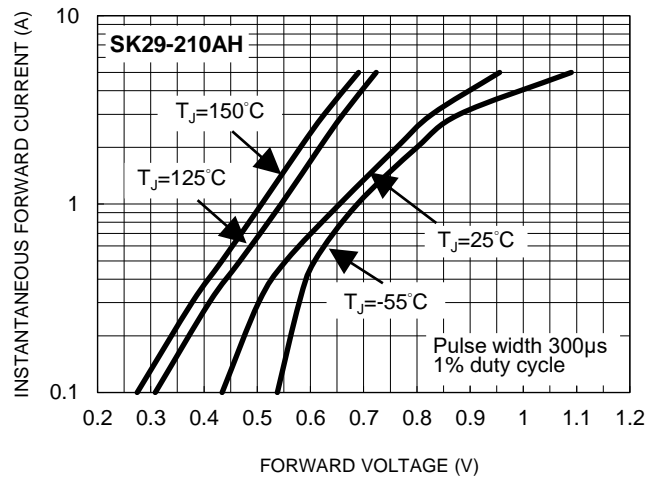

Fig.11 Typical Reverse Characteristics

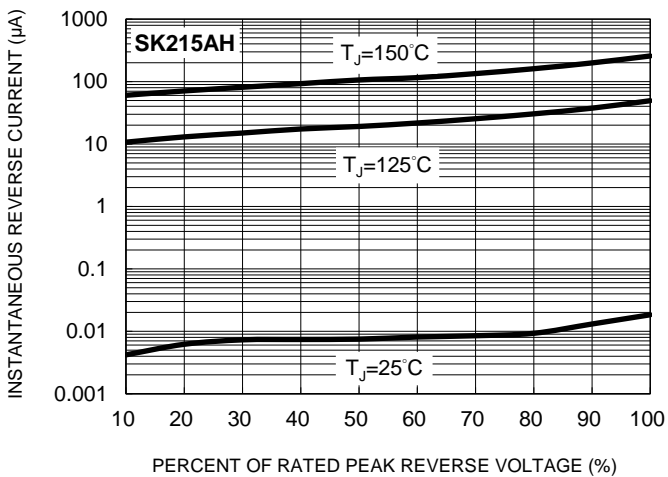
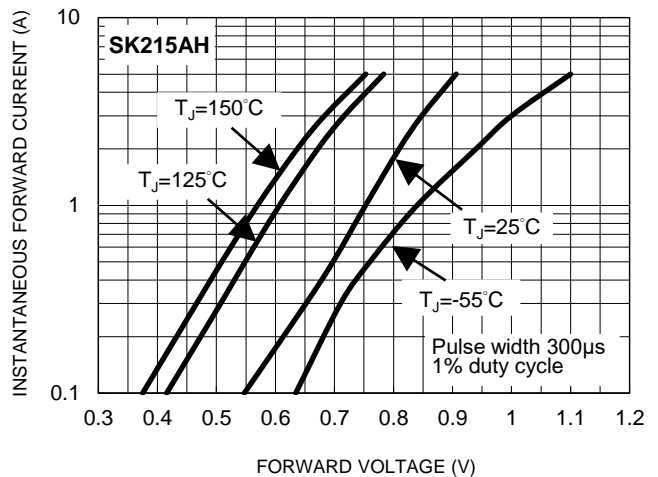

Fig.12 Typical Forward Characteristics



CHARACTERISTICS CURVES

($T_A = 25^\circ\text{C}$ unless otherwise noted)

Fig.13 Typical Forward Power Dissipation vs. Forward Current

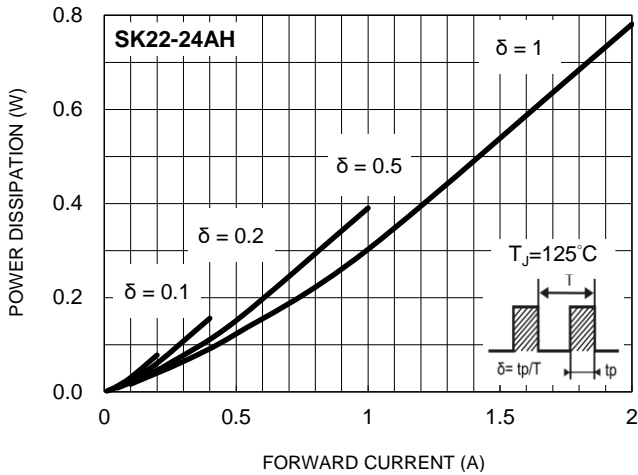

Fig.14 Typical Forward Power Dissipation vs. Forward Current

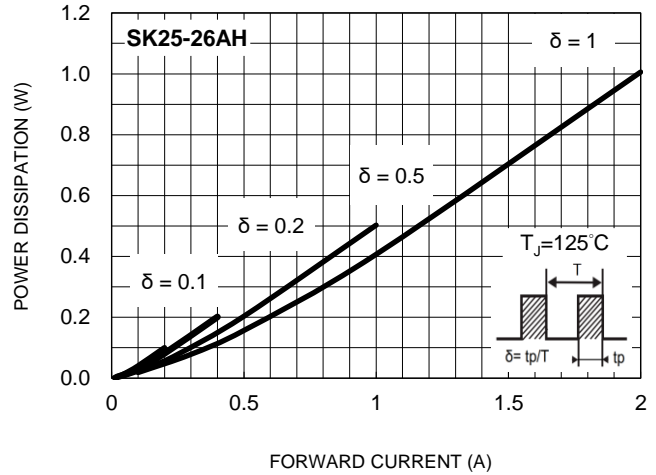

Fig.15 Typical Forward Power Dissipation vs. Forward Current

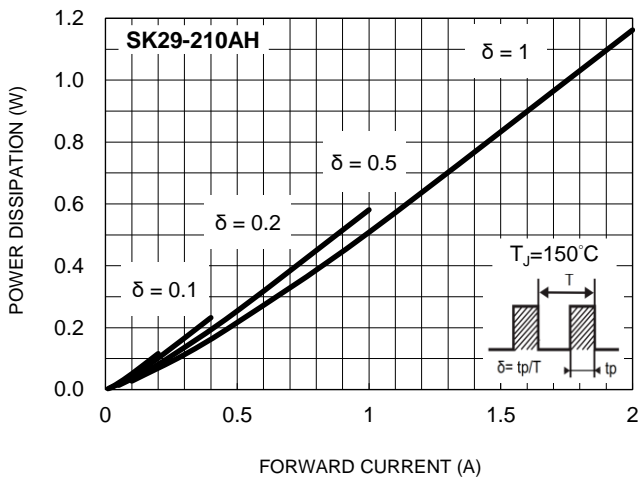

Fig.16 Typical Forward Power Dissipation vs. Forward Current

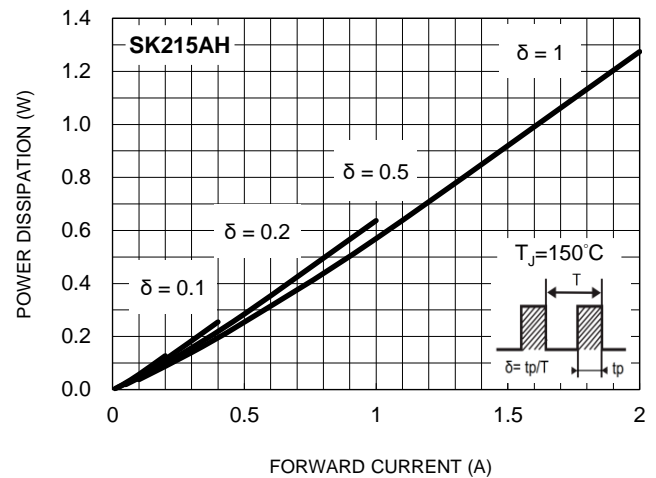
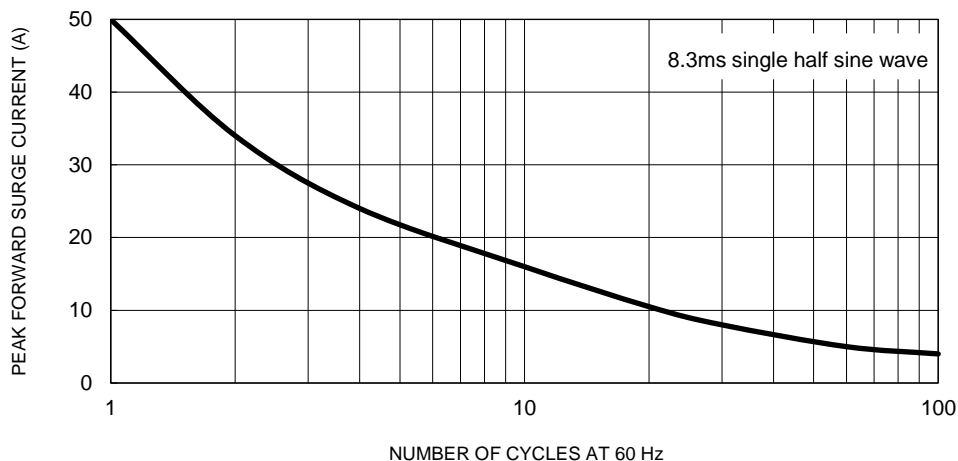

Fig.17 Maximum Non-Repetitive Forward Surge Current



CHARACTERISTICS CURVES

($T_A = 25^\circ\text{C}$ unless otherwise noted)

Fig.18 Typical Transient Thermal Characteristics

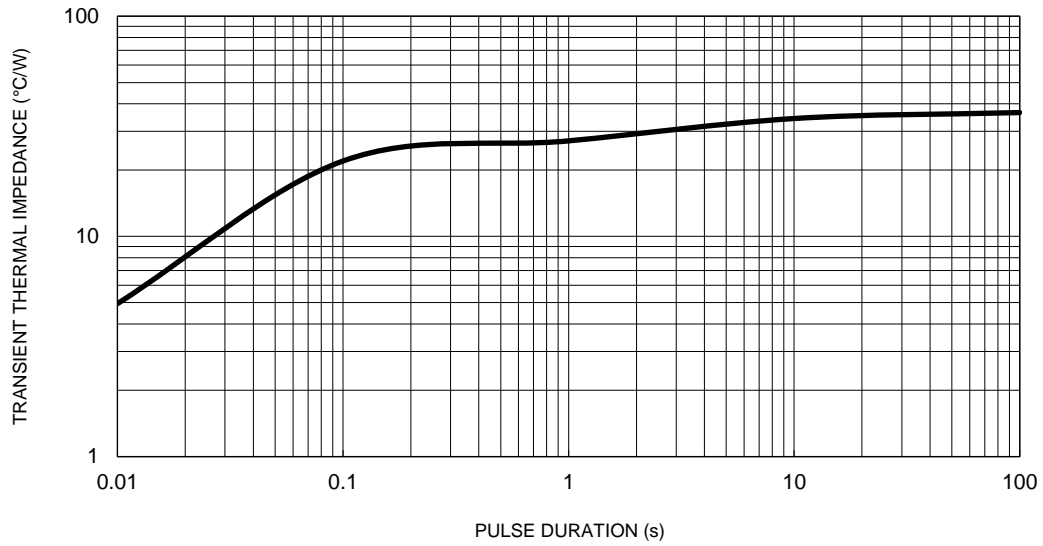

PACKAGE OUTLINE DIMENSIONS

DO-214AC (SMA)

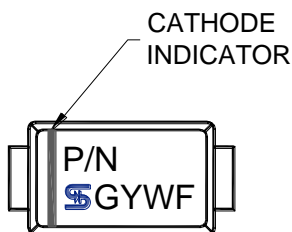
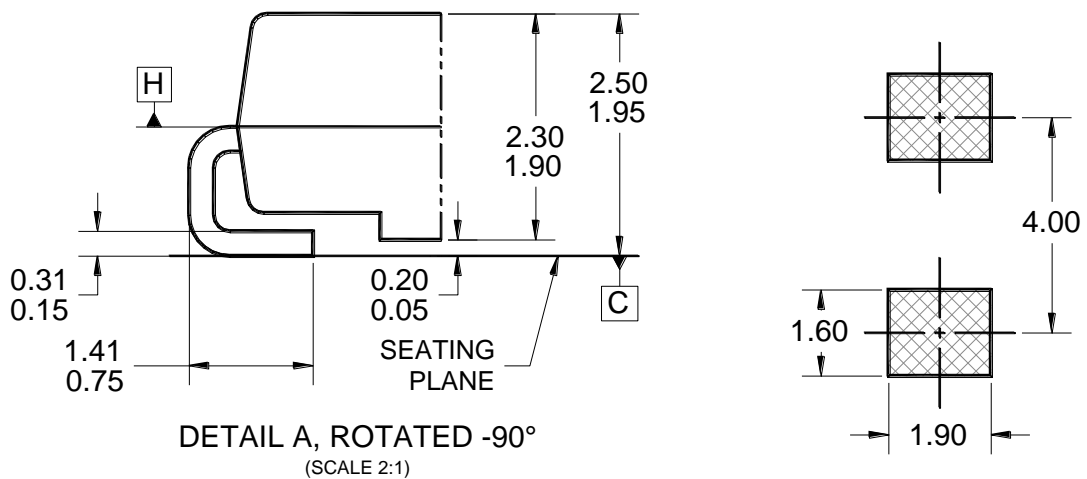
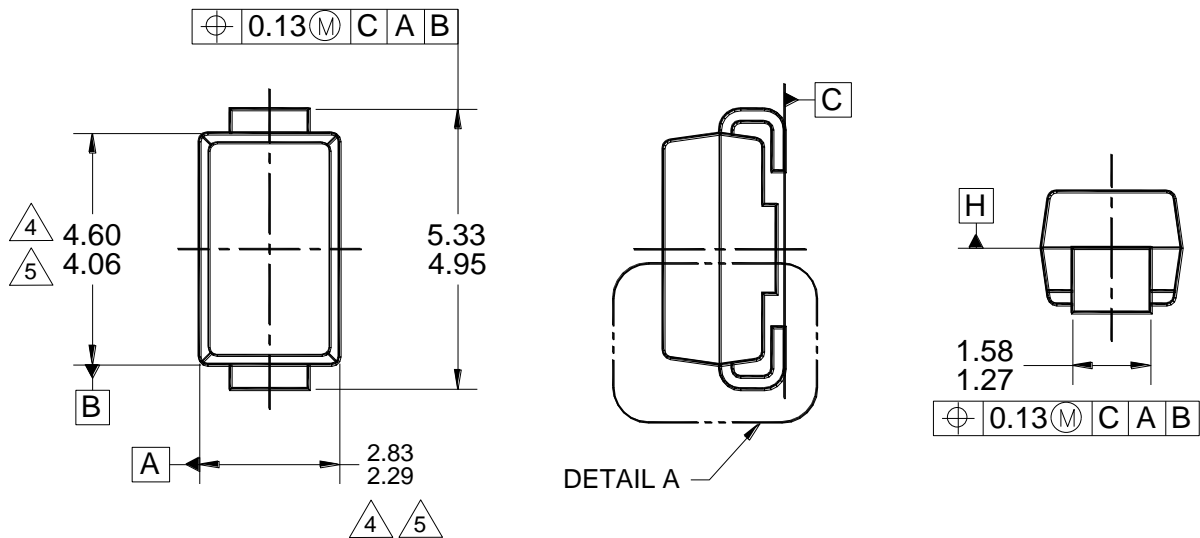

MARKING DIAGRAM

P/N = MARKING CODE
G = GREEN COMPOUND
YW = DATE CODE
F = FACTORY CODE

NOTES: UNLESS OTHERWISE SPECIFIED

1. ALL DIMENSIONS ARE IN MILLIMETERS.
2. DIMENSIONING AND TOLERANCING PER ASME Y14.5M-1994.
3. PACKAGE OUTLINE REFERENCE: JEDEC DO-214, VARIATION AC, ISSUE D.
4. MOLDED PLASTIC BODY DIMENSIONS DO NOT INCLUDE MOLD FLASH.
5. MOLDED PLASTIC BODY LATERAL DIMENSIONS TO BE DETERMINED AT DATUM PLANE H.
6. DWG NO. REF: HQ2SD07-DO214SMC-034 REV A.

Notice

Specifications of the products displayed herein are subject to change without notice. TSC or anyone on its behalf assumes no responsibility or liability for any errors or inaccuracies.

Purchasers are solely responsible for the choice, selection, and use of TSC products and TSC assumes no liability for application assistance or the design of Purchasers' products.

Information contained herein is intended to provide a product description only. No license, express or implied, to any intellectual property rights is granted by this document. Except as provided in TSC's terms and conditions of sale for such products, TSC assumes no liability whatsoever, and disclaims any express or implied warranty, relating to sale and/or use of TSC products including liability or warranties relating to fitness for a particular purpose, merchantability, or infringement of any patent, copyright, or other intellectual property right.

The products shown herein are not designed for use in medical, life-saving, or life-sustaining applications. Customers using or selling these products for use in such applications do so at their own risk and agree to fully indemnify TSC for any damages resulting from such improper use or sale.